



OpenPCBLGR  
GitHub Repository

## Workshop

# Resonator Design: The OpenPCBLGR

---

Thorsten Maly  
Bridge12 Magnetic Resonance  
RMC, Denver, 07/23 – 07/27/2023



# What to expect from this Workshop

- This is not an electrical engineering class
  - Light on theory
  - Heavy on “how to ...”
    - Applied electrical engineering
- This is not a substitution to crack open a book
  - E.g. Poole “Electron Spin Resonance” (1983 edition ...)
- It should serve as an inspiration

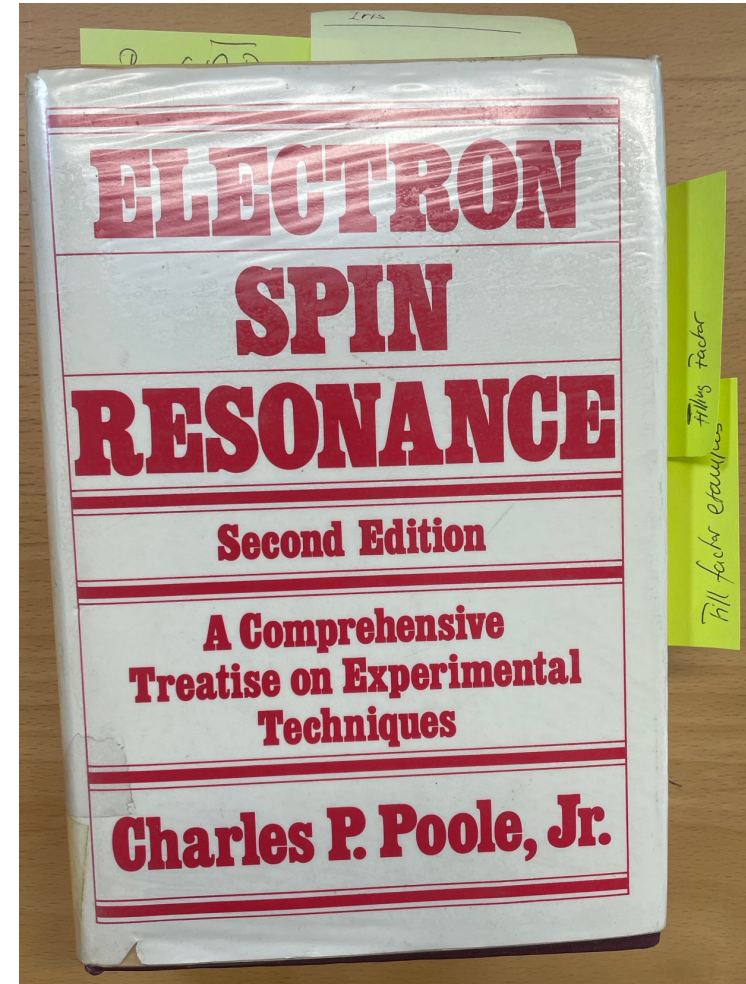

Abebooks.com: ~ 16 \$

# Simple Reflection Bridge

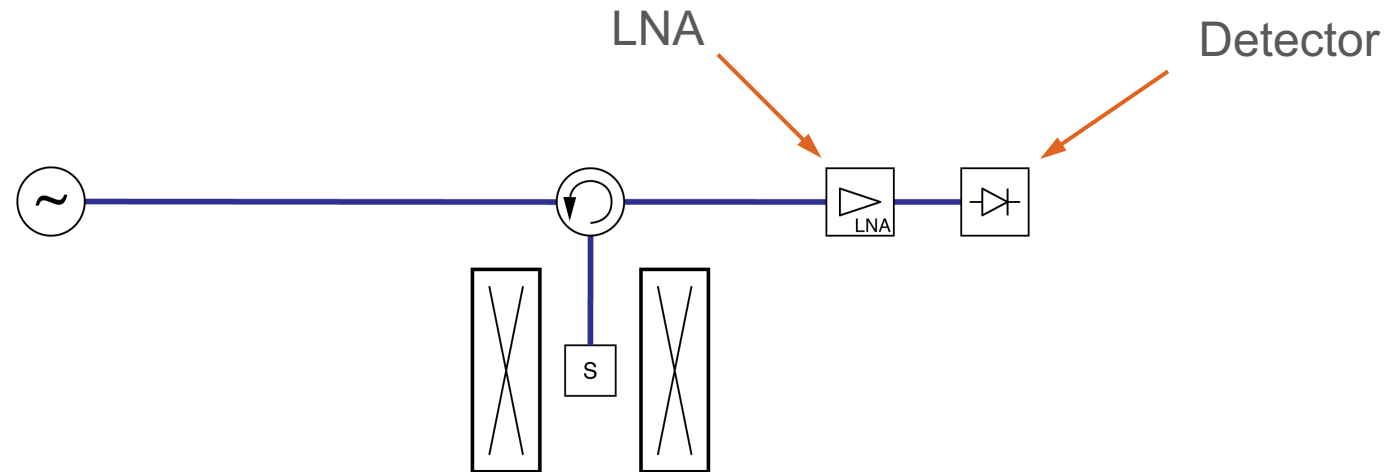

- Basic setup for EPR detection
- Source protection through circulator
- Reflected power is directed to detector
- No phase information (superposition of absorption and dispersion signal)

# Reflection Bridge with Reference Arm

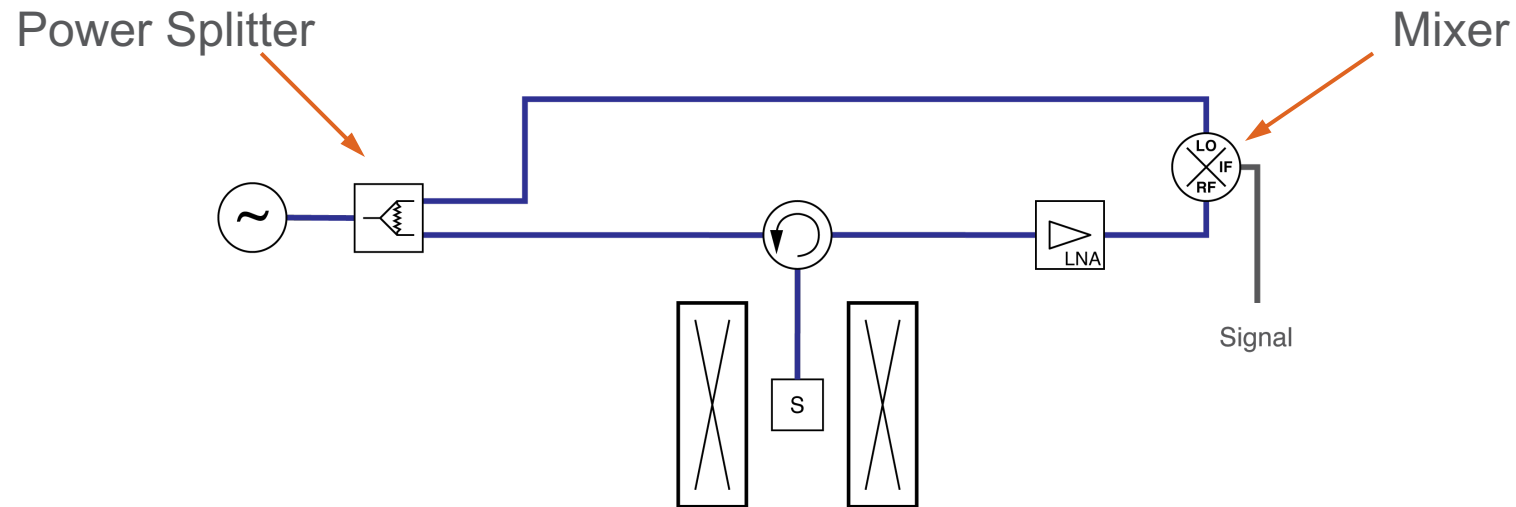

- Phase sensitive EPR signal detection (reference arm)
- Increased sensitivity
- Operates at fundamental frequency

# Superheterodyne Bridge

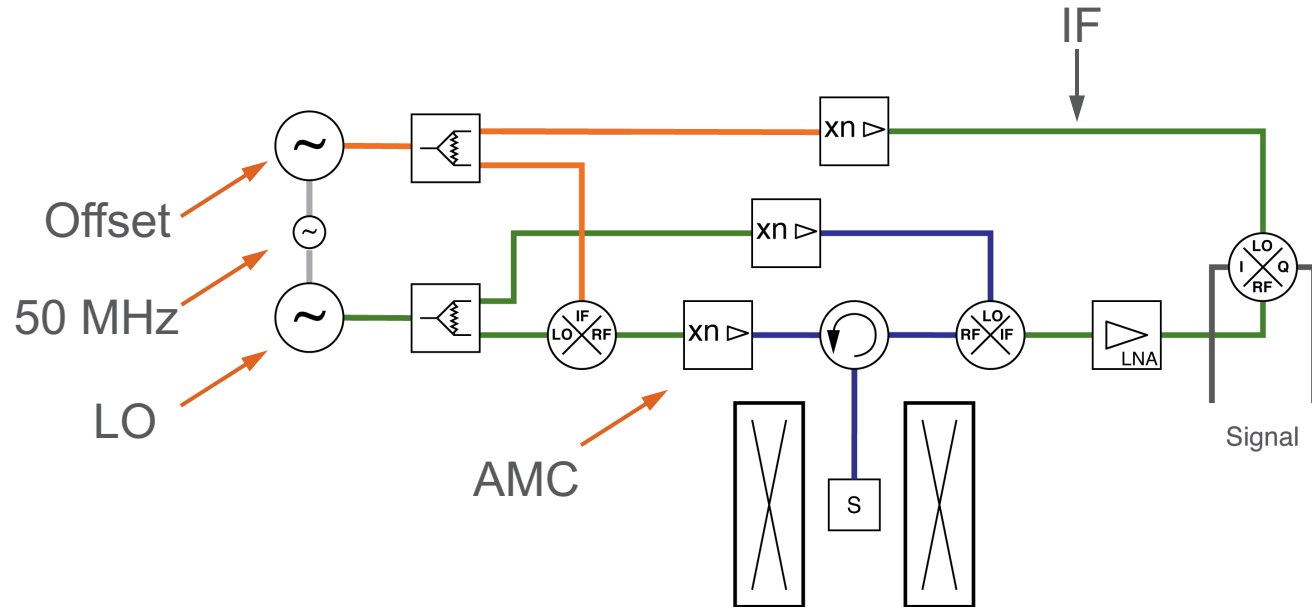

- Highly sophisticated setup for high-field EPR spectroscopy
- Maximum sensitivity (amplification at IF)
- Create/Shape pulses at LO frequency

# EPR Resonators

## ■ What is a Resonator?

- Can be a simple rectangular box or pipe
- In EPR spectroscopy the  $TE_{102}$  cavity is THE classic EPR resonator

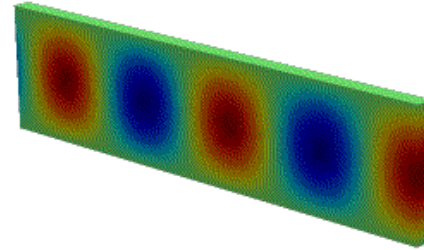

$TE_{10}$  Waveguide Mode

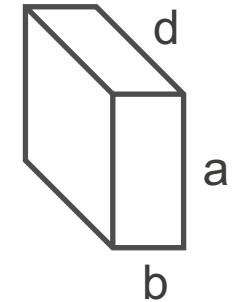

## ■ Why a Resonator?

- EPR signals are small
- Amplify the signal (increase sensitivity)

Rectangular cavity operates in a  $TE_{mnl}$

$$f_{mnl} = \frac{c}{2\sqrt{\mu_r \epsilon_r}} \sqrt{\left(\frac{m}{a}\right)^2 + \left(\frac{n}{b}\right)^2 + \left(\frac{l}{d}\right)^2}$$

# Resonance Frequencies in a Rectangular TE<sub>mnl</sub> Cavity

Waveguide	a	b	l (mode)	Frequency	d (calc.)
WR-90	0.900 in. (22.86 mm)	0.400 in. (10.16 mm)	2	9.50 GHz	1.717 in. (43.61 mm)
WR-90	0.900 in. (22.86 mm)	0.400 in. (10.16 mm)	3	9.50 GHz	2.575 in. (65.4 mm)
WR-28	0.280 in. (7.11 mm)	0.140 in. (3.56 mm)	2	34 GHz	0.443 in. 11.24 mm
WR-4.3	0.043 in. (1.09 mm)	0.022 in. (0.56 mm)	2	260 GHz	0.054 in. 1.36 mm

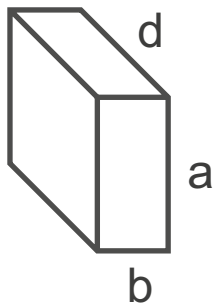

$$f_{mnl} = \frac{c}{2\sqrt{\mu_r \epsilon_r}} \sqrt{\left(\frac{m}{a}\right)^2 + \left(\frac{n}{b}\right)^2 + \left(\frac{l}{d}\right)^2}$$

# Microwave Coupling to the Resonator

## ■ Waveguide Coupling

- Electric fields in waveguide are coupled to resonator using an iris
- The iris changes the matching between the waveguide and resonator

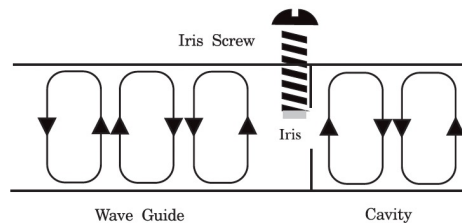
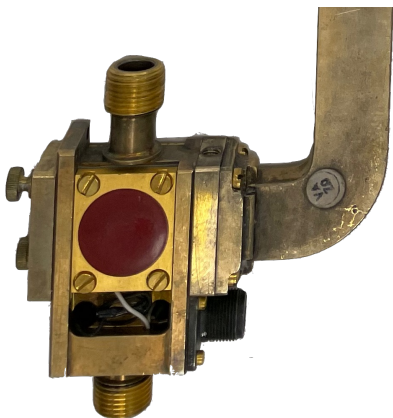

Bruker Training Course Material

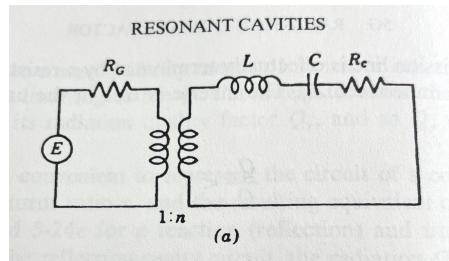

Poole, Electron Spin Resonance

## ■ (SMA) Coupling Antenna

- Can be loop or stub
- Couple to (residual) H or E fields of the resonator
- Moving the position changes matching

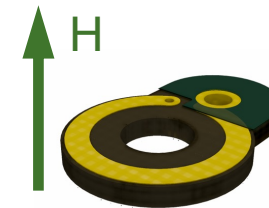



# Characterizing the EPR Resonator

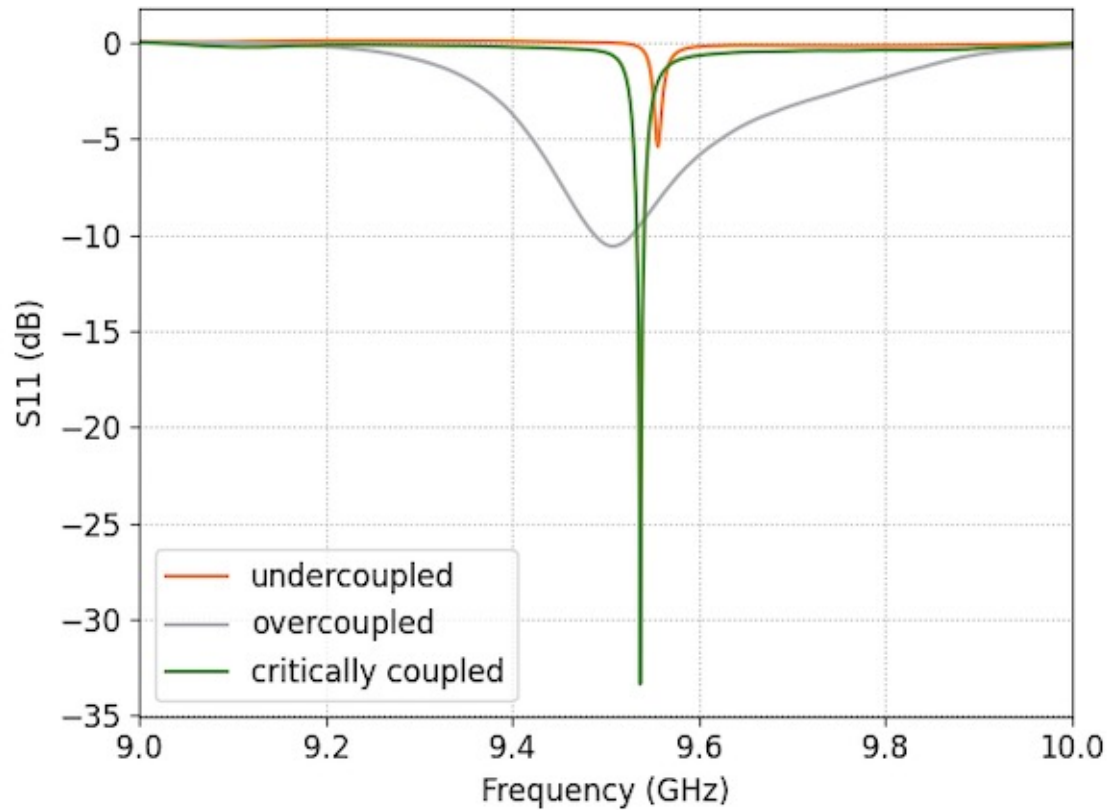

## 3 Coupling regimes

- Undercoupled ( $\beta < 1, \Gamma > 0$ )
- Critically Coupled ( $\beta = 1, \Gamma = 0$ )
- Overcoupled ( $\beta > 1, \Gamma < 0$ )

$\beta$  – Coupling Coefficient,  $\Gamma$  – Reflection Coefficient

$$\text{Resonator Quality factor: } Q = \frac{\nu}{\Delta\nu}$$

Determines the Resonator Bandwidth

# Characterizing the EPR Resonator

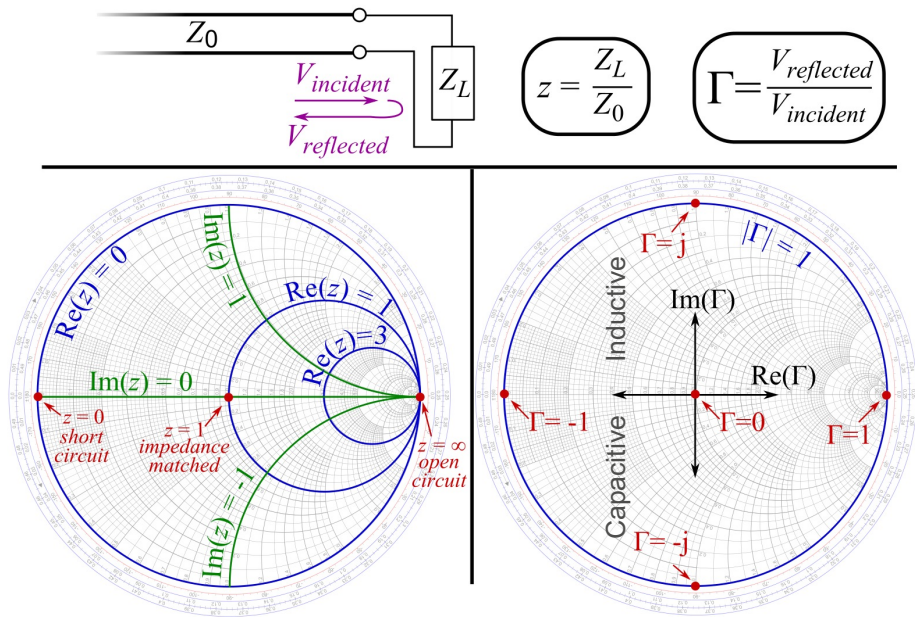

Source: [https://en.wikipedia.org/wiki/Smith\\_chart](https://en.wikipedia.org/wiki/Smith_chart)

## 3 Coupling regimes

- Undercoupled ( $\beta < 1, \Gamma > 0$ )
- Critically Coupled ( $\beta = 1, \Gamma = 0$ )
- Overcoupled ( $\beta > 1, \Gamma < 0$ )

$\beta$  – Coupling Coefficient,  $\Gamma$  – Reflection Coefficient

$$\text{Resonator Quality factor: } Q = \frac{\nu}{\Delta\nu}$$

Determines the Resonator Bandwidth

- $S_{11}$  plot tells you *whether* a probe is coupled
- Reflection coefficient as measured by VNA is a complex number
  - Negative: Capacitive Reactance
  - Positive: Inductive Reactance
- Smith Chart tells you *how* the probe is coupled

# Commercial EPR Resonators

Varian TE<sub>102</sub>



Bruker Flexline



Bridge12

X-Band



Q-Band



- High-quality, high-fidelity resonators
- Best performance
- Expensive research instruments

# Open-Source Hardware

- **Arduino**
  - Low-cost (~ 30 \$) microcontroller board
  - Introduced in 2005. By 2021 reportedly sold 10M boards
  - Philosophy: If you want to start learning about electronics, don't start with algebra, learning should start at day one
  - Introduced shields to expand functionality
  - Easy to learn programming and electronics
    - It's still C++ but the IDE makes it easy
- **Open-Source Hardware Designs**
  - All relevant information to recreate hardware is publicly available
    - Assembly instructions, bill of materials
  - Emphasis on low-cost
  - Take advantage of digital manufacturing (3D printing)
  - Build a strong community
  - Publish under OS license

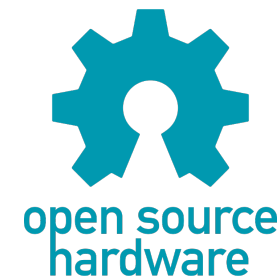
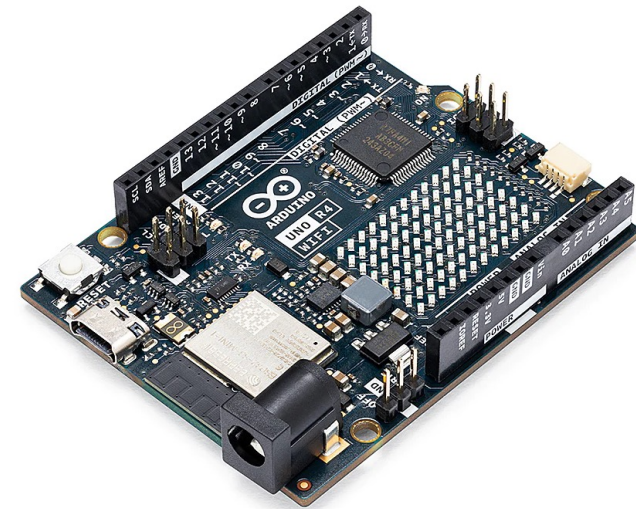

# Open-Source Hardware @ Bridge12

## Build Instrumentation

### Instrumentation for Magnetic Resonance

Build low-cost resonators for x-band EPR spectroscopy or make NMR coils using different techniques.

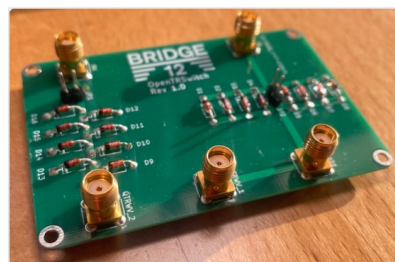

#### OpenTRSwitch

Build a transmit/receive switch for NMR spectroscopy.

[More Info](#)



#### OpenPCBLGR

Build a low-cost loop-gap resonator (LGR) for x-band EPR spectroscopy.

[More Info](#)

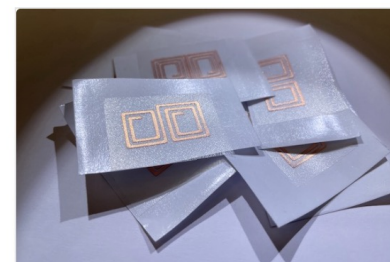

#### Vinal Cutter NRM Coils

Make multi-turn NMR coils using a vinyl cutter

[More Info](#)

[www.bridge12.com/learn](http://www.bridge12.com/learn)

# Open-Source PCB Loop-Gap Resonator (LGR)

## Objectives

- Inexpensive hardware/materials
  - Keep costs < 100 \$
- Easy to assemble, modify, and adapt
- Must be educational and fun
  - Acquire new skills

## Strategy

- Use commercial off-the-shelve (COTS) components
- Avoid expensive machining
  - Utilize 3D printing
  - Use commercial PCB fab house



OpenPCBLGR  
GitHub Repository

# Loop-Gap Resonators for EPR Spectroscopy are Not New

JOURNAL OF MAGNETIC RESONANCE 47, 515-521 (1982)

## COMMUNICATIONS

### The Loop-Gap Resonator: A New Microwave Lumped Circuit ESR Sample Structure

W. FRONCISZ\* AND JAMES S. HYDE

National Biomedical ESR Center, Department of Radiology, Medical College of Wisconsin,  
8701 Watertown Plank Road, Milwaukee, Wisconsin 53226

Received February 23, 1982

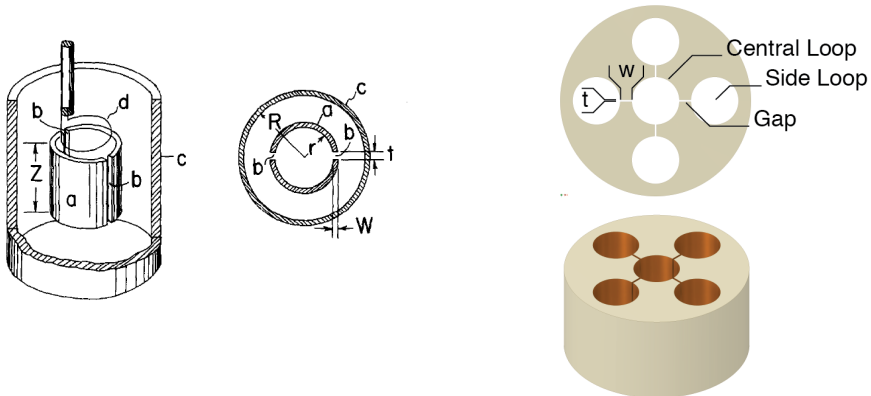

- LGR can be described as a lumped-element circuit
  - Inductivity given by the loops
  - Capacitance given by the gaps
- LGR Pros
  - Large filling factor
  - Large conversion factor
  - Good field homogeneity
  - Large bandwidth (low Q), good for pulsed experiments
- LGR Cons
  - Small gaps are challenging to machine using traditional machining
  - Field modulation coils for cw experiments is challenging
    - Solid resonator
    - Gold plated Macor

Froncisz, W., and James S. Hyde. *J. Magn. Reson.* (1982).

Rinard, George A., and Gareth R. Eaton. *Biomedical EPR, Part B: Methodology, Instrumentation, and Dynamics.* (2005).

Sidabras, Jason W., et al. *J. Magn. Reson.* (2017).

# Field Modulation, Microwaves, and Skin Depth

Copper Skin Depth vs Frequency

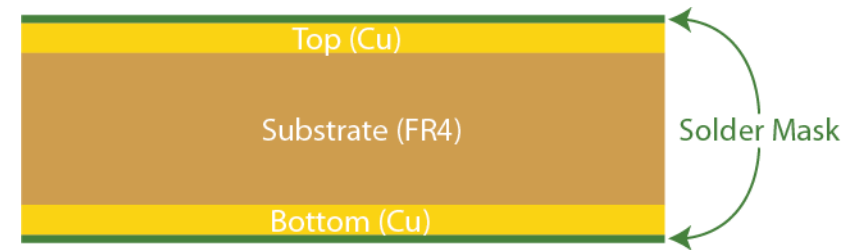
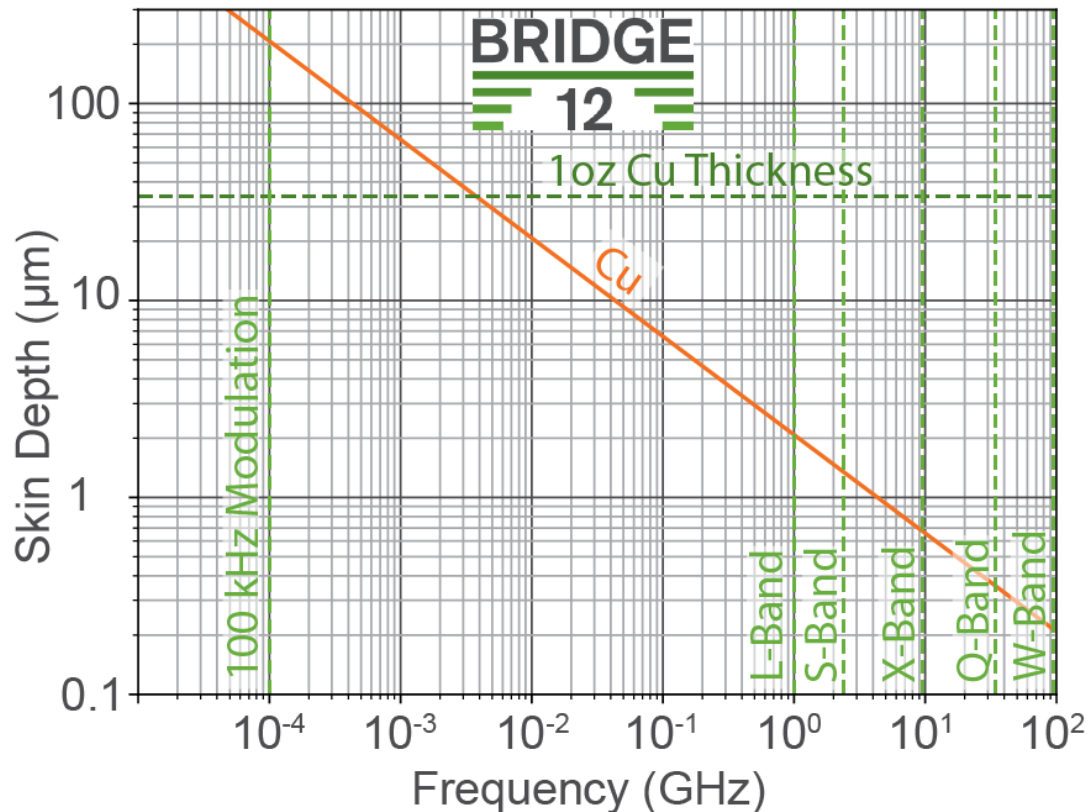

- Typical Cu amount for PCBs is 1 oz/ft<sup>2</sup>
  - ≈ 32 μm copper thickness
- Field Modulation
  - At 100 kHz,  $\delta \sim 200 \mu\text{m}$
  - Field modulation can penetrate
- Resonator
  - At 9.5 GHz,  $\delta \sim 0.65 \mu\text{m}$
  - Microwave fields are confined



# LGR Design Parameters

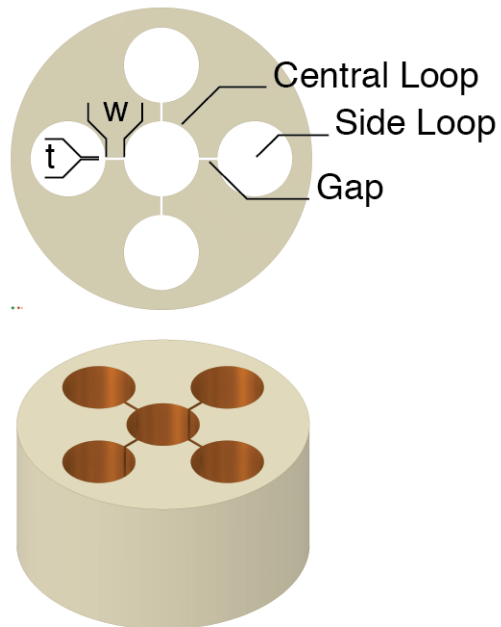

Parameter	Value
Number of loops and gaps	3L2G
Central loop diameter (sample access)	5.2 mm
Return loop diameter	6.0 mm
Gap length and width	Form Simulations
Resonator Height	5 – 10 mm
Resonator Frequency	9.5 GHz

# LGR Resonator Dimensions

## ■ Design Parameters

- 9.5 GHz
- 5 mm Sample Access
- Height ~10 mm

## ■ PCB Manufacturer Capabilities

- Minimum Plated Slot Width: 0.65 mm
- Max Plated Hole Diameter: 6.3 mm

## ■ Determined from Simulations

- Gap Length: 1.6 mm

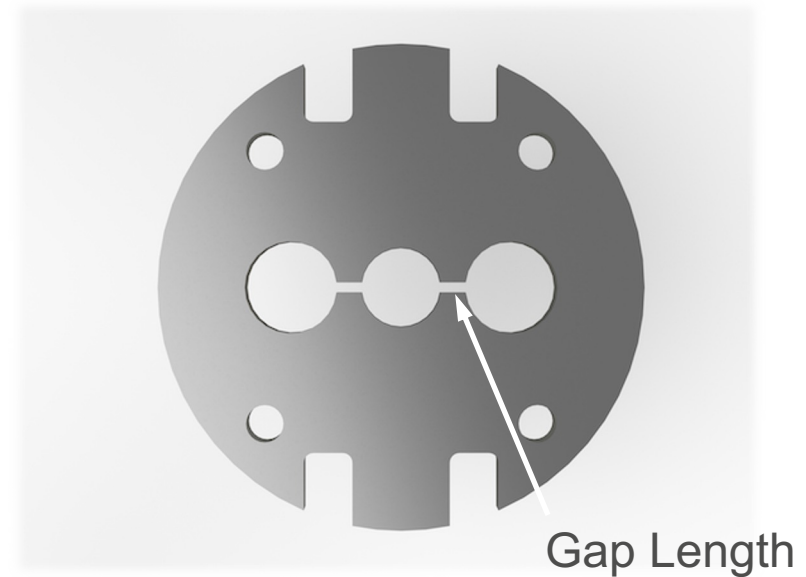

# HFSS Simulations

## Eigenmode Simulations

Resonator Model  
(5 PCBs, 8 mm)

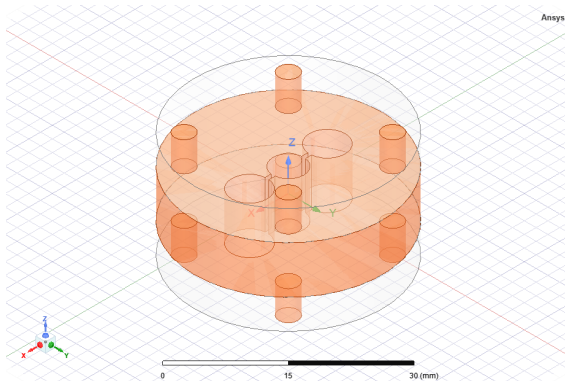
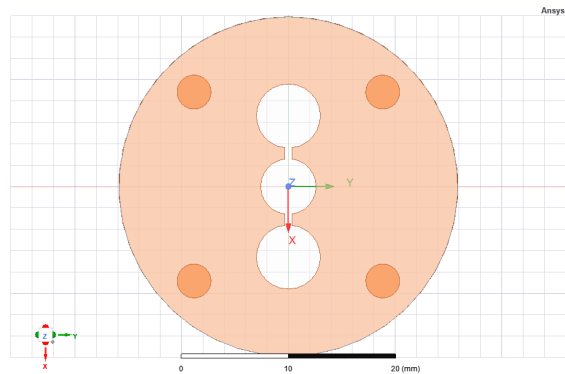

H-Field

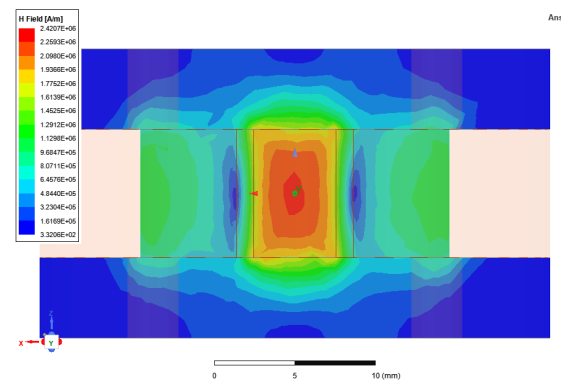
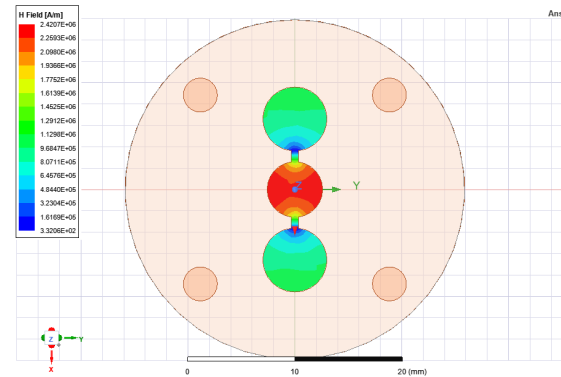

E-Field

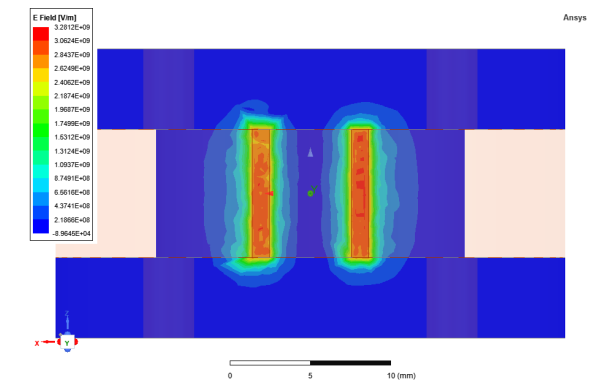
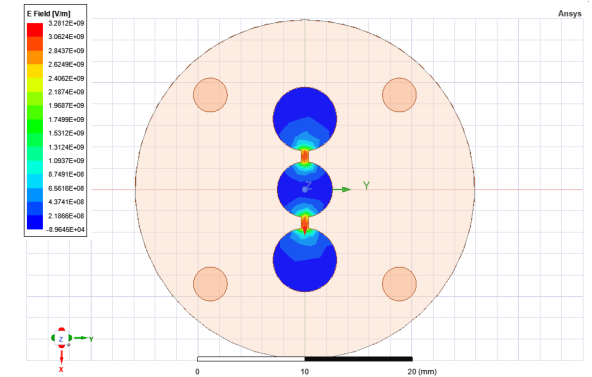

# Microwave Coupling via PCB Based Loop Antenna

- PCB Coupling Loop
  - Robust
  - Reproducible
  - Easy to solder

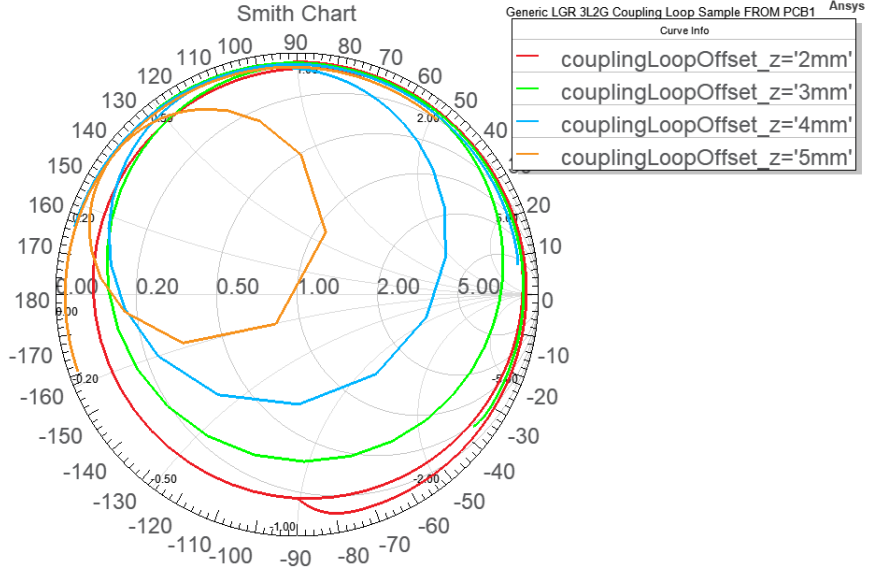
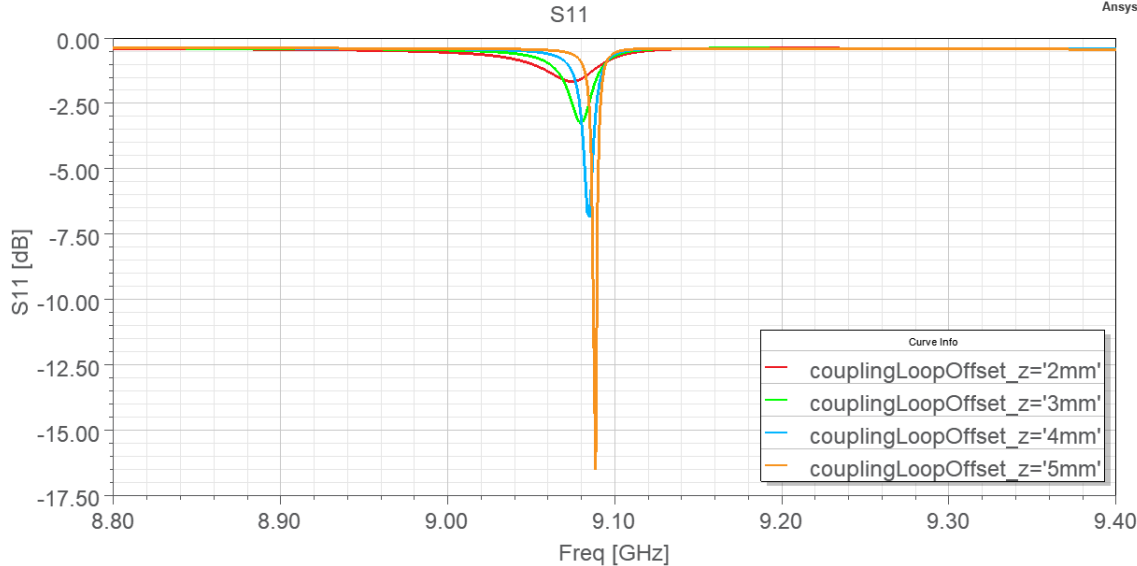
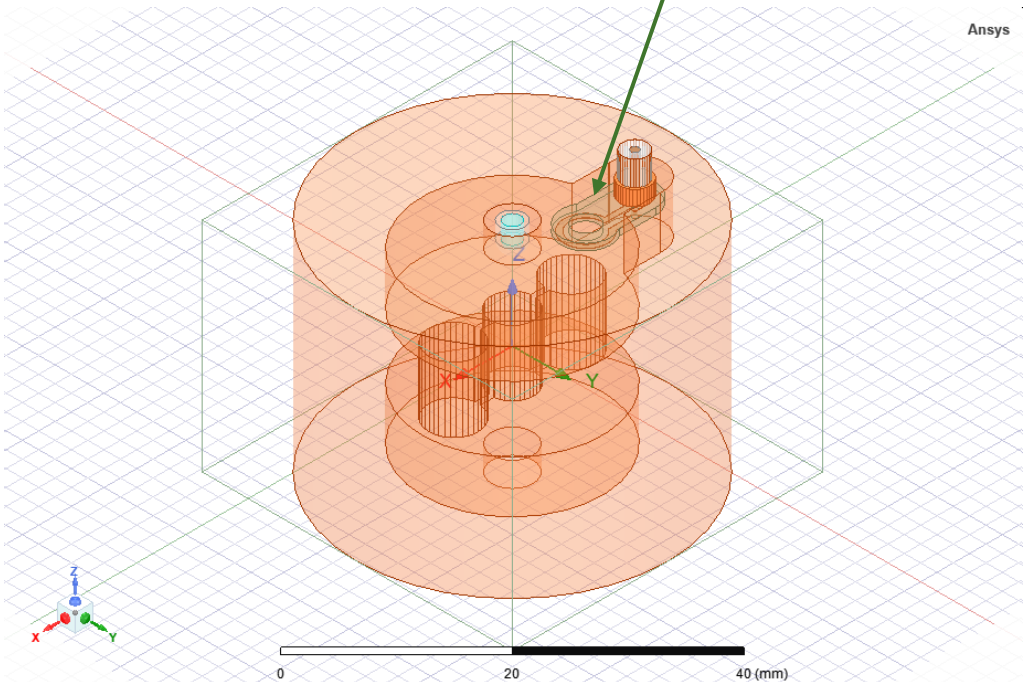

# First Generation X-Band PCB LGR

3L2G Resonator

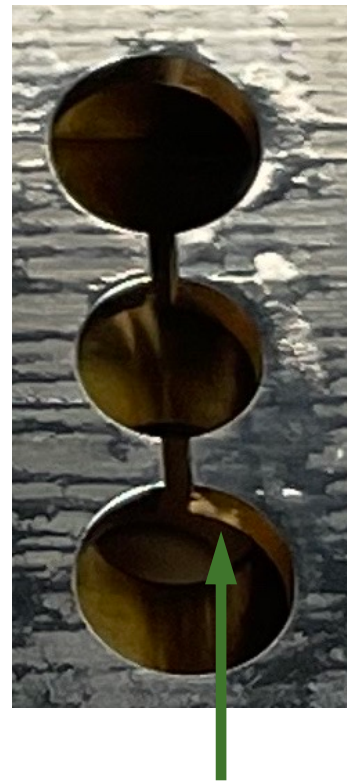

Edge Plating

PCB Frequency Statistics

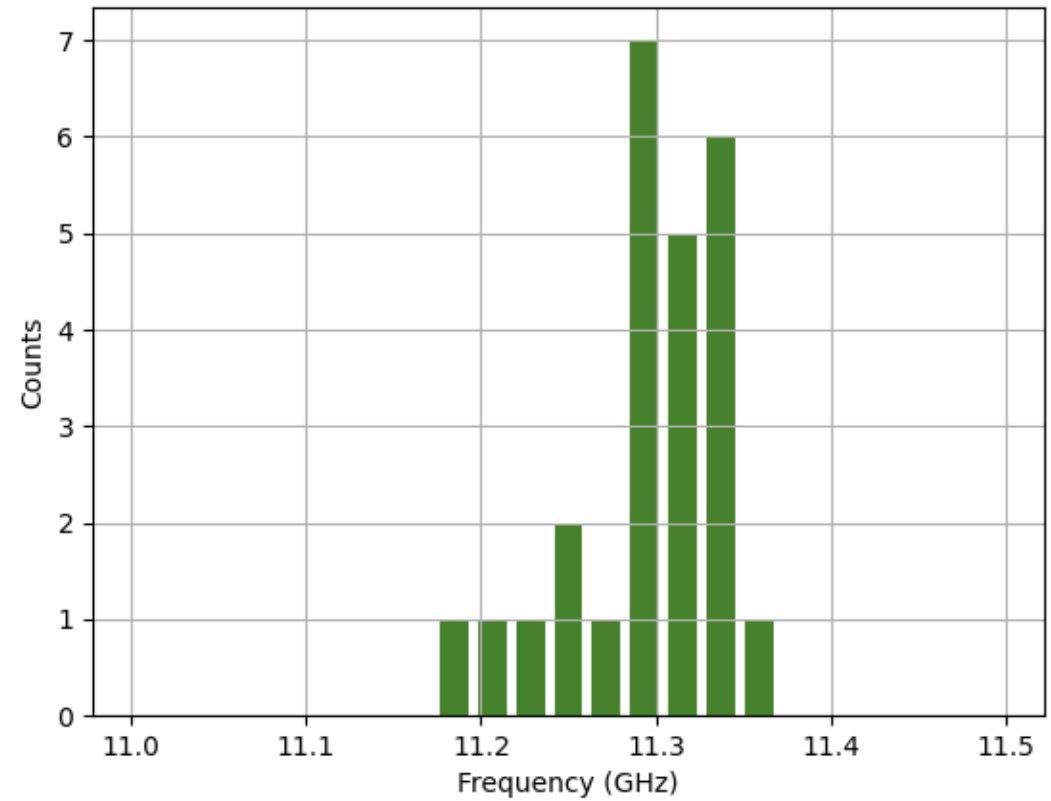

# First Generation X-Band PCB LGR

3L2G Resonator



Edge Plating

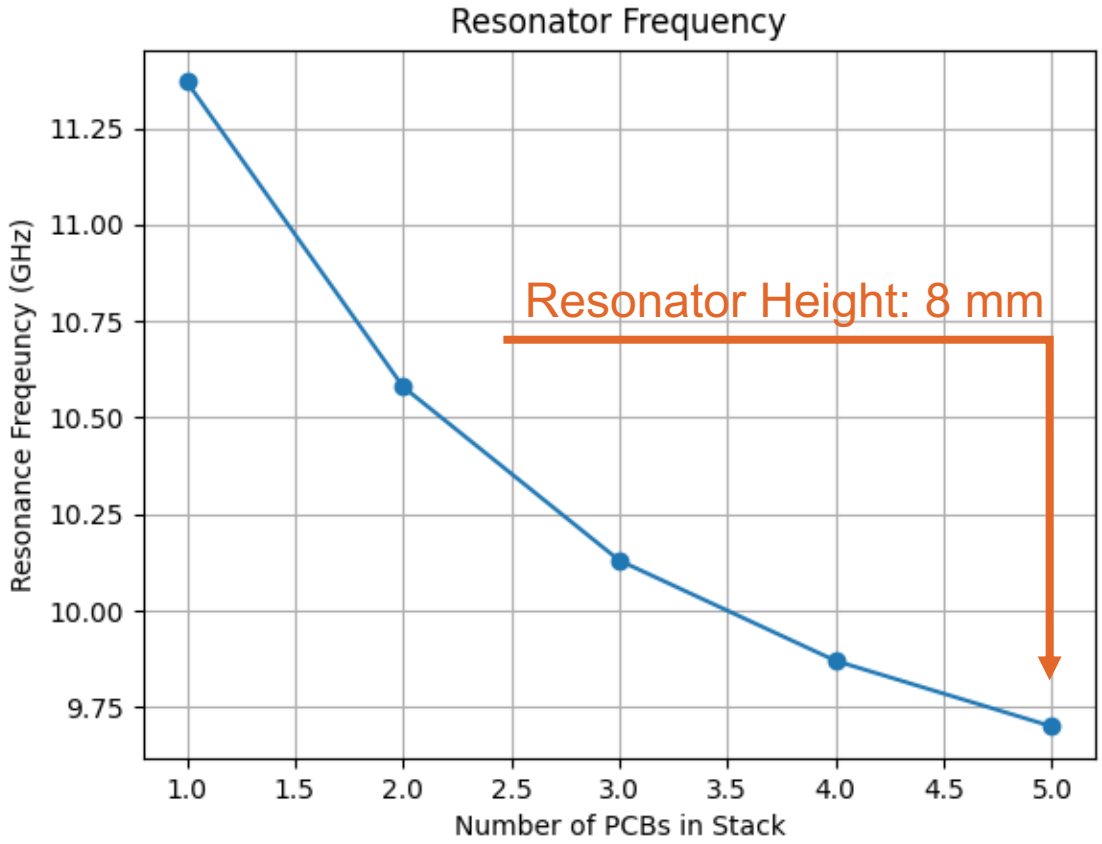

# Mechanical Design and Assembly of PCB Resonator



Single PCB Resonator



Assembled Resonator



Modulation Coils

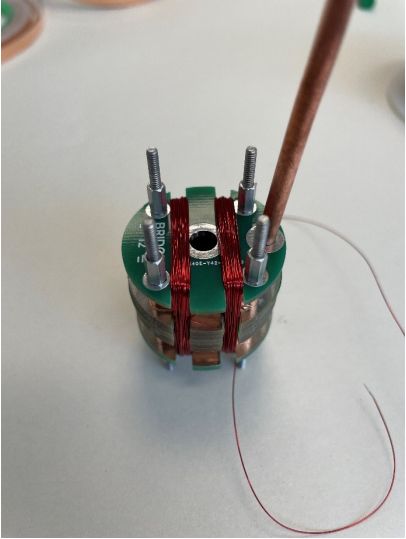

3d Printed Shield



Fully Assembled

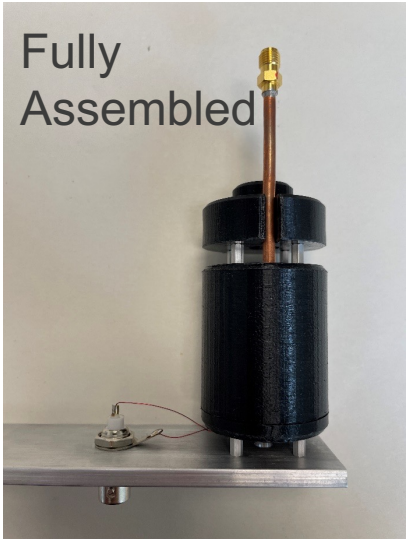

# Microwave Performance

## VNA Measurements and Conversion Factor Simulations

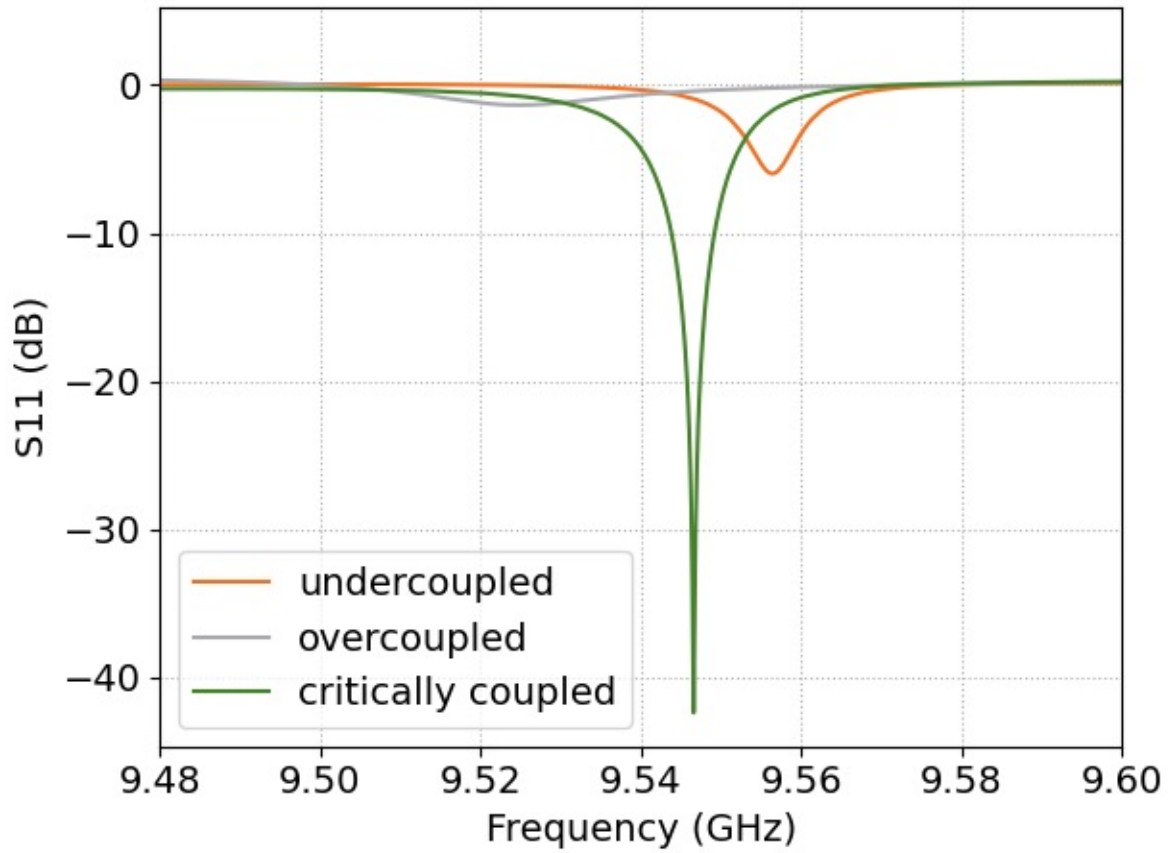

HFSS Simulation:  $B_1$  along Sample Axis

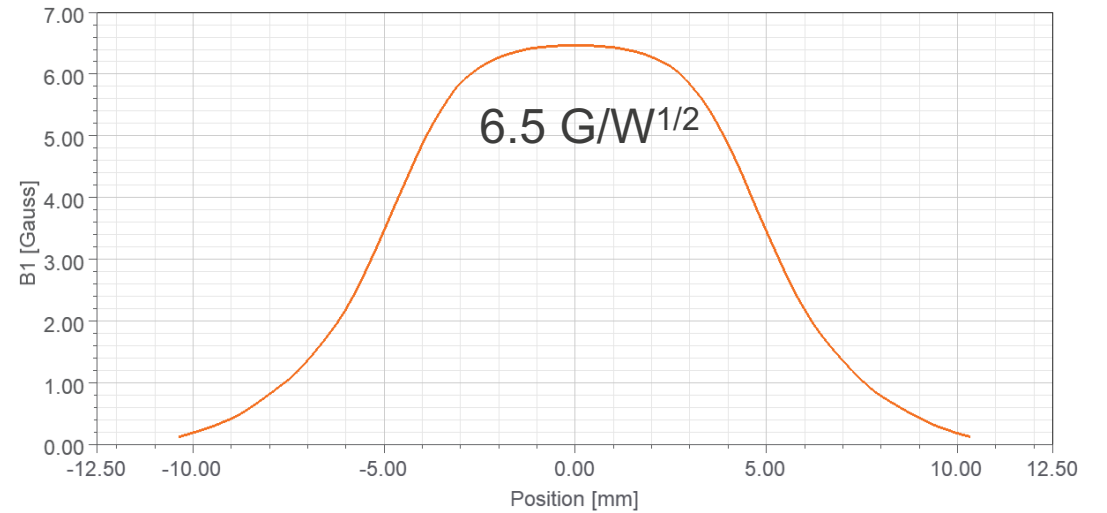

- Critically Coupled,  $Q = 600-1000$
- Overcoupled,  $Q < 100$  ( $\sim 100$  MHz BW)



# Adjusting Resonator Height

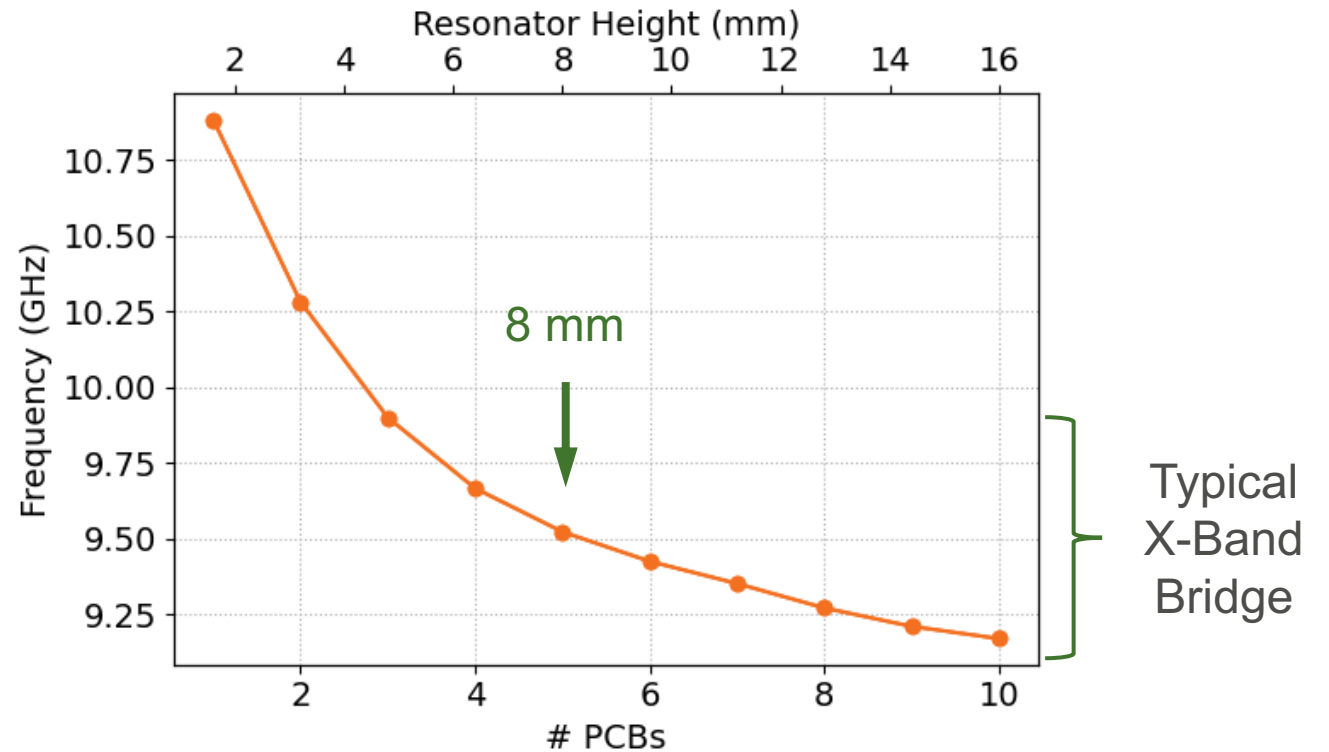

Height of 3.6 - 9.6 mm compatible with commercial X-band spectrometers

# EPR Setup and Measurements

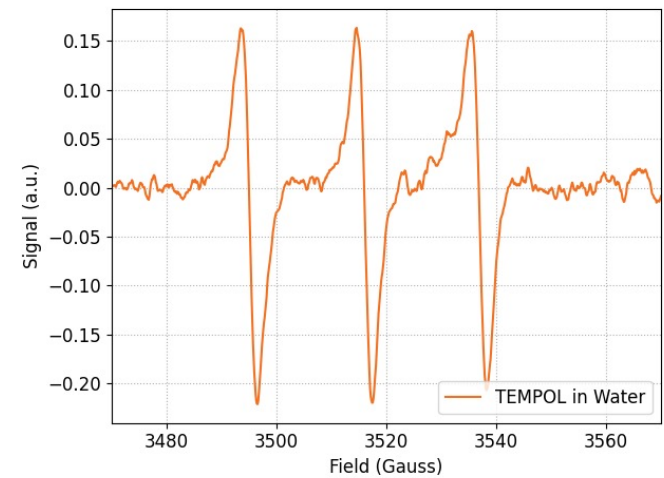
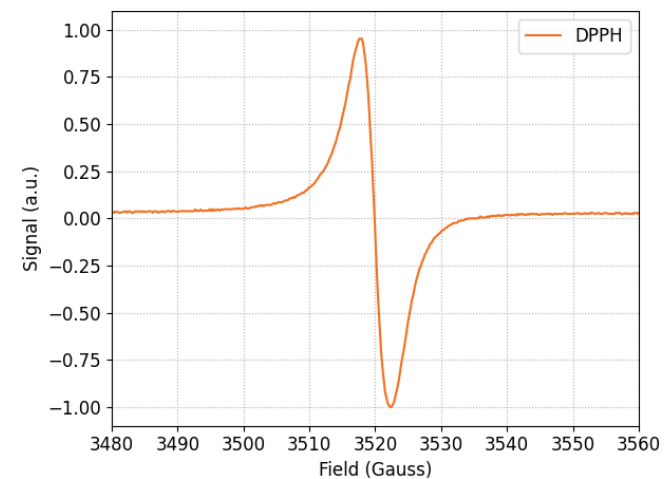
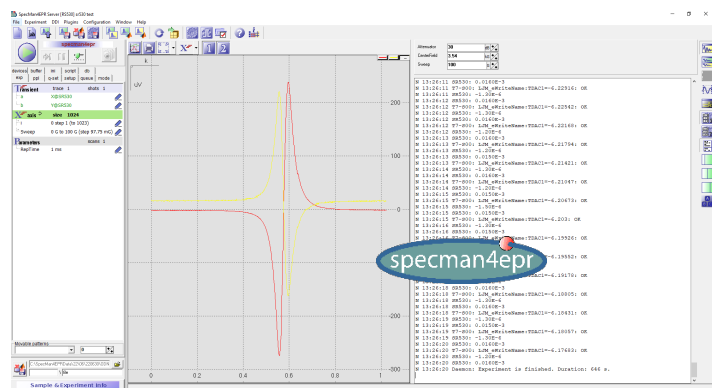
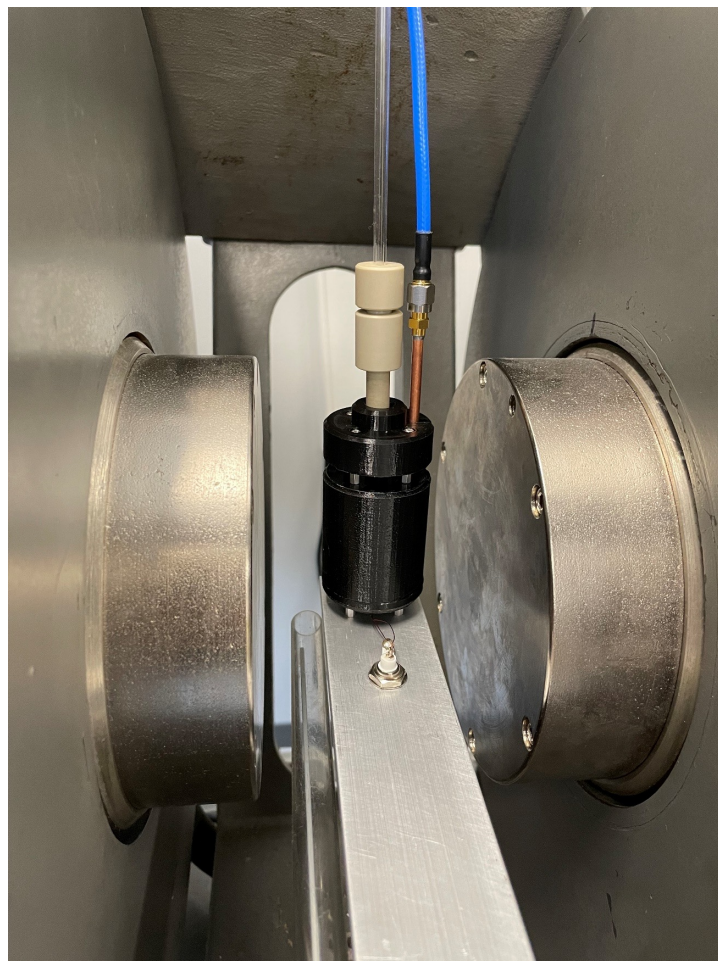

DNP Literature Blog:

Twitter:

Email:

[blog.bridge12.com](http://blog.bridge12.com)

[@thmaly](https://twitter.com/thmaly)

[tmaly@bridge12.com](mailto:tmaly@bridge12.com)

**THANK YOU**



# Selected References

## ■ EPR Instrumentation

- Reijerse et al., “Electron Paramagnetic Resonance Instrumentation.” In *EMagRes*, edited by Robin K. Harris and Roderick L. Wasylishen, 187–206. Chichester, UK: John Wiley & Sons, Ltd, 2017. <https://doi.org/10.1002/9780470034590.emrstm1511>.

## ■ Smith Chart

- <https://www.analog.com/en/technical-articles/impedance-matching-and-smith-chart-impedance-maxim-integrated.html>

## ■ Loop Gap Resonators

- Froncisz et al., “A New Microwave Lumped Circuit ESR Sample Structure.” *Journal of Magnetic Resonance (1969)* 47 (May 1, 1982): 515–21. [http://dx.doi.org/10.1016/0022-2364\(82\)90221-9](http://dx.doi.org/10.1016/0022-2364(82)90221-9).
- Rinard et al. “Loop-Gap Resonators.” In *Biomedical EPR, Part B: Methodology, Instrumentation, and Dynamics*, 19–52. Boston, MA: Springer US, 2005. [https://link.springer.com/chapter/10.1007/0-306-48533-8\\_2](https://link.springer.com/chapter/10.1007/0-306-48533-8_2).
- Tschaggelar et al., “High-Bandwidth Q-Band EPR Resonators.” *Applied Magnetic Resonance* 48 (December 1, 2017): 1273–1300. <https://doi.org/10.1007/s00723-017-0956-z>.

## ■ Coupling to the Resonator

- Mett et al. “Coupling of Waveguide and Resonator by Inductive and Capacitive Irises for EPR Spectroscopy.” *Applied Magnetic Resonance* 35 (2008): 285–318. <https://doi.org/10.1007/s00723-008-0162-0>.